



networktesters.com
tel: 01865 601008

PTP Testing Overview

Accurate frequency distribution through packet switched networks can be understood as an extension of the TDM synchronization network based on a few new building blocks like the *Synchronous Ethernet Equipment Clock (EEC)* and the *Packet-based Equipment Clock (PEC)*. However, for time and phase distribution applications, where most of the interest resides today, this approach does not work

Time and phase synchronization require new synchronization architectures. The challenges to deliver the required accuracy level are especially important in these new scenarios. There is also a renewed interest in synchronization testing related both with network commissioning tasks and troubleshooting.

This paper reviews existing testing techniques applicable to frequency distribution and introduces the new techniques for phase and time applications. A minimum description of the technologies that enable accurate phase and time distribution, including the *Packet Time Protocol (PTP)* is also addressed.

1. PTP PROFILES

PTP plays a central role in most time and phase synchronization architectures and is the key technology in all current applications requiring a high degree of accuracy, usually in the range of a few microseconds and sometimes in the sub-microsecond range.

The IEEE 1588-2008 standard, where PTP is defined, is flexible enough to allow for very different ways of using the protocol, including both frequency and time distribution applications. Due to its flexibility, PTP may operate in different profiles. These profiles

are not interoperable with each other; they offer different performance levels and involve different requirements for the network.

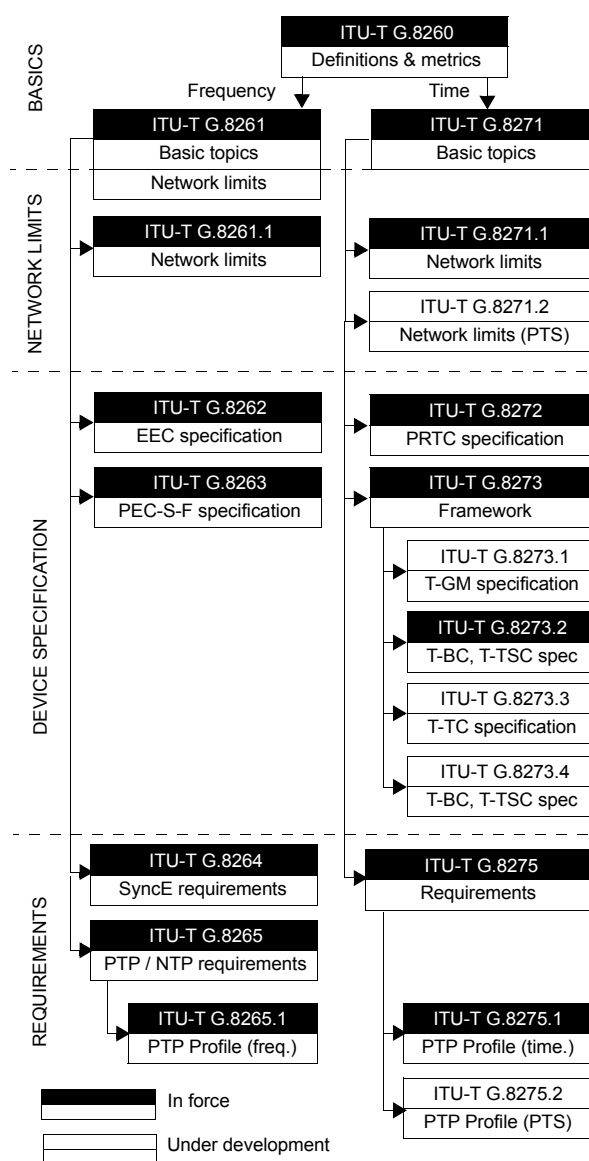

Figure 1 ITU-T packet switched network synchronization standards and the relationship among them.

As stated in IEEE 1588-2008, the purpose of a PTP profile is to allow organizations to define specific selections of attribute values and optional features of PTP that, when using the same transport protocol, inter-work and achieve a performance that meets the requirements of a particular application.

Typical profile examples are the *Default profiles* defined in IEEE 1588-2008 (two basic general purpose profiles), the *Power Profile* (IEEE C37.238-2011), the *Enterprise profile* (currently an IETF draft) and the *Telecom profiles* (ITU-T G.8265.1, G.8275.1 and G.8275.2). Discussion about the PTP Telecom profiles together with the Default profiles are the main subject of this paper.

Table 1

Summary of ITU-T PTP Telecom Profiles main settings

	ITU-T G.8065.1	ITU-T G8275.1
Frame structure	UDP	Ethernet
Addressing mode	Unicast	Multicast
One way / Two way	Both	Two way
One step / two step	Both	Both
Path delay mechanism	End-to-end	End-to-end
Domain	4 ~ 23	24 ~ 43
Priority 1 range	-	128
Priority 2 range	-	0 ~ 255
Local priority range	1 ~ 255	1 ~ 255
Class	80 ~ 110	6, 7, 135, 140, 150, 160, 165, 248, 255
Time scale	Arbitrary, PTP	PTP
BMCA	Static BMCA	Alternate BMCA
Sync message rate	1/16 ~ 128	16
Delay request message rate	1/16 ~ 128	16
Announce transmission rate	1/16 ~ 8	8
Announce receive timeout	2	2 ~ 10

The ITU-T G.8265.1 Frequency Profile

The aim of the ITU-T G.8275.1 PTP profile for frequency synchronization is to adapt PTP to the common telecom network synchronization practices. The purpose of this profile is not to provide better performance than any previous protocol or to define new functionality in the synchronization net-

work but to extend the existing network to include PTP as a protocol suitable to carry synchronization with a minimum impact in the installed infrastructure based on TDM technology (or Synchronous Ethernet).

One interesting feature of the ITU-T G.8265.1 profile is the ability to operate in one-way mode. PTP masters use the *Sync* message flow to share time stamps with their peers (slave clocks, boundary clocks). If time synchronization between the master and its peers is required, then the time it takes for the remote end to receive the time stamp has to be compensated for in some way. This is done through either the *end-to-end* or *peer-to-peer* path delay mechanisms. If no time synchronization is required, there is no need to apply any delay compensation and the message flows associated to the path delay mechanism could be removed. This one-way operation mode is allowed by IEEE 1588-2008 and it is optional within ITU-T G.8265.1.

PTP operation has to be compatible with existing telecommunication networks which may not include specific support for PTP. Actually, it is assumed that the network may be completely unaware of PTP. This requirement restricts the way the protocol has to be deployed in several aspects:

- *UDP over IPv4* (IEEE 1588-2008, Annex D) is the chosen transport protocol rather than Ethernet or other protocols. This is because of the universal availability of IPv4.
- *Unicast* is the only allowed transmission mechanism. Multicast may be more efficient but provisioning multicast is also more complex and it may not be available, or even if it is available the network administrator may decide to restrict its use for security reasons. In ITU-T G.8265.1 networks, PTP slaves must request permission from the master to exchange PTP messages through the signaling mechanism defined by IEEE 1588-2008 and complemented by ITU-T G.8265.1.
- *No on-path support* through boundary or transparent clocks is used. Actually, PTP masters (PEC-M) and slaves (PEC-S) are the only PTP entities considered by ITU-T G.8265.1 profile. To compensate for the lack of support from the network, the ITU-T G.8265.1 standard allows for message rates higher than in other profiles

(up to 128 messages/s for Sync and Delay request messages). Another consequence of the lack of on-path support is that the path delay mechanism cannot be peer-to-peer and therefore if a path delay mechanism is used it has to be end-to-end.

One of ITU-T G.8261 most important requirements is the need for smooth inter-operation with existing synchronization networks. Some features added for this purpose are:

- Re-use of the ITU-T G.781 *Quality Level* (QL). ITU-T synchronization networks and IEEE PTP networks both have their own way to signal the quality level they are supplying. The ITU-T model is based in QL codes included in the *Synchronization Status Message* (SSM), PTP uses the *clockClass* attribute. These mechanisms are not compatible, and therefore the *clockClass* cannot be directly used by ITU-T networks. To add compatibility between both models ITU-T G.8261 defines a range within the *clockClass* to add the ITU-T G.781 QL values. With this modification, network elements can handle a PTP reference in the same way as with SDH or Synchronous Ethernet inputs.

- *Definition of a new clock reference selection algorithm*. Telecom networks must behave in a very predictable way. Synchronization slaves choose their time reference using static value configured in the device (the *Local priority*), the QL if available, and certain alarms detected in the clock interface such as *Loss Of Signal* (LOS) or the *Alarm Indication Signal* (AIS). These mechanisms are replicated by (1) defining a *Local priority* for PTP to replace *Priority 1* and *Priority 2*, (2) replacing the dynamic and somewhat unpredictable *Best Master Clock Algorithm* (BMCA) defined in IEEE 1588-2008 by the more simple and more deterministic Static BMCA (which works in the same way as the normal decision algorithm used in telecom networks to choose the synchronization reference), (3) defining a new *Packet Timing Signal Fail* (PTSF) alarm to distribute information about synchronization faults such as loss of announce messages, loss of timing messages or excessive *Packet Delay Variation* (PDV).

The ITU-T G.8275.1 Phase / Time Profile

Unlike ITU-T G.8265.1, the purpose of ITU-T G.8275.1 is to enable the deployment of accurate phase and time distribution in a telecommunications network based on the PTP protocol. Also unlike ITU-T G.8265.1, the ITU-T time profile requires extensive on-path support; actually, all network equipment that must deal with PTP traffic must be PTP aware. Switches must implement the *Telecom Boundary Clock* (T-BC) function and endpoints may be, depending on their role, *Telecom Grandmasters* (T-GMs) or *Telecom Time Slave Clocks* (T-TSCs). *Transparent clocks* are not used. All these are mandatory requirements within ITU-T G.8275.1 and they justify the name of *PTP telecom profile for phase / time synchronization with full timing support from the network*.

The strong on-path support requirements from the ITU-T time profile limits its applicability to Greenfield deployments or to networks simple and modern enough to allow for a deep re-engineering. For this reason, there is a work in progress within the ITU-T to publish a new PTP profile for phase / time synchronization, but requiring only partial timing support. This new profile will be released as the ITU-T G.8275.2 standard.

Table 2

ITU-T G.784 and G.8265.1 Quality Levels

ITU-T G.781 QL	ITU-T G.8265.1 QL	Option I	Option II
0	82	-	QL-STU
1	80	-	QL-PRS
2	84	QL-PRC	-
3	88	-	-
4	90	QL-SSU-A	QL-TNC
5	92	-	-
6	94	-	-
7	86	-	QL-ST2
8	96	QL-SSU-B	-
9	98	-	-
10	102	-	QL-ST3 / QL-EEC2
11	104	QL-SEC / QL-EEC1	-
12	106	-	QL-SMC
13	100	-	QL-ST3E
14	108	-	QL-PROV
15	110	QL-DNU	QL-DUS

Why is the ITU-T time profile so demanding? The answer is that modern applications (most often, applications related with cellular and wireless communications) require highly accurate time and phase synchronization, usually in the microsecond range. Another answer to the same question is that requirements are so strict because technology exists that is capable to fulfill these requirements, even if it is at a considerable engineering cost.

Table 3
Cellular interfaces and their phase accuracy requirements

Application	Requirement
GSM, WCDMA-FDD, LTE-FDD	None
TD-SCDMA	$\pm 1.5 \mu\text{s}$
CDMA2000	$\pm 3 \mu\text{s}, \pm 10 \mu\text{s}$
WiMAX-TDD	$\pm 1 \mu\text{s}, \pm 1.5 \mu\text{s}$
LTE-TDD	$\pm 1.5 \mu\text{s}, \pm 5 \mu\text{s}$
LTE-A	$\pm 1.5 \mu\text{s}, \pm 5 \mu\text{s}$

The ITU-T G.8275.1 profile is designed for maximum performance and efficiency and hence the frame structure is Ethernet (IEEE 1588-2008) with multicast addressing. This is well suited for the current architecture of Metropolitan Area Networks (MANs) that are based on Ethernet pseudowires and other related technologies.

One of the key features of ITU-T G.8275.1 is grandmaster selection and protection. The *Alternate BMCA* defined by this standard is a compromise between the determinism required by telecom networks and the flexibility of the default BMCA from IEEE 1588-2008.

The Alternate BMCA is a dynamic protocol, in the same way as the IEEE 1588-2008 BMCA. However, unlike the IEEE 1588-2008 BMCA, the Alternate BMCA defines a fixed role for each PTP entity: T-GM, T-TSC or T-BC. The IEEE 1588-2008 *Ordinary Clocks* (OCs) which may become masters or slaves depending on the result of the BMCA are not allowed within the ITU-T G.8275.1 framework. The purpose of the Alternate BMCA is to let the slave clocks decide which grandmaster to use and to allow for a dynamic, loop-free architecture. With this objective in mind, the ITU-T phase / time protocol

defines a new port-specific attribute, *notSlave*, that is set to *true* in the T-GM, *false* in the T-TSC and configurable to *true* or *false* in the T-BC.

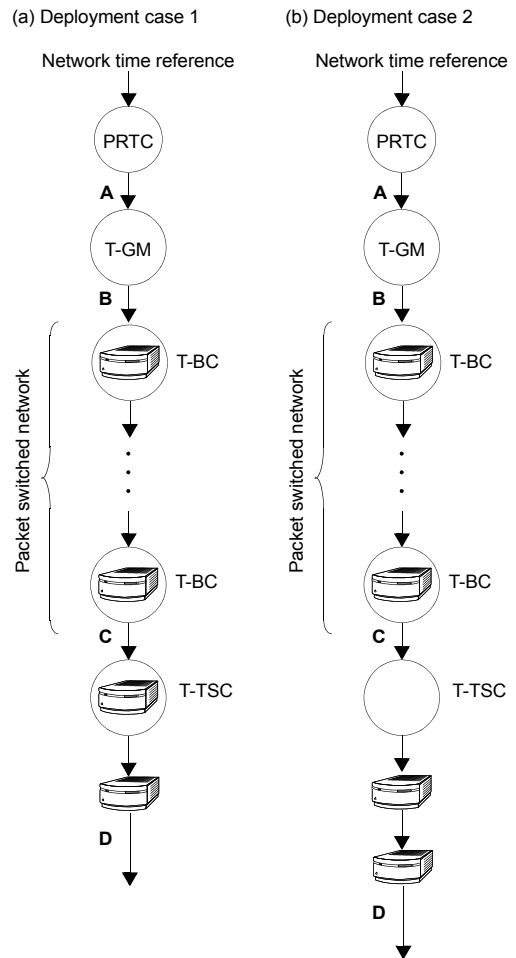

Figure 2 ITU-T G.8271.1 / G.8275.1 network reference model. The PTP endpoints are T-GMs and T-TSCs. All packet transmission / switching network elements implement the T-BC function.

The ways the priorities are managed by the Alternate BMCA also differ from the IEEE 1588-2008 BMCA. *Priority 1* is not used and it is statically configured to 128. There is a new port specific attribute, the *Local Priority*, that is not delivered in *Announce* messages; it is appended to the messages received in the relevant port and it is then used in the decision algorithm. Actually, the decision algorithm as been modified: In the Alternate BMCA, the *clockClass* attribute has the strongest weight.

The *clockClass* attribute from ITU-T G.8265.1 can not be reused in this profile because the ITU-T G.781 classes are usable for frequency references only. Instead, the phase / time profile defines a

new QL scale. The new *clockClass* scale allows for T-GMs or T-BCs that may operate in partial holdover state without a usable time reference but still traceable to some frequency source such as a PRC or a *Synchronization Supply Unit* (SSU).

Table 4
ITU-T G.8275.1 *clockClass* attribute

Class	Entity	F.trac eable	Meaning
6	T-GM	True	Connected to a PRTC in locked mode (e.g., PRTC traceable to GNSS)
7	T-GM	True	Holdover, within holdover specification, traceable to QL-PRC / QL-PRS frequency source
7	T-GM	False	Holdover, within holdover specification, non-traceable to QL-PRC / QL-PRS frequency source
135	T-BC	True	Holdover, within holdover specification, traceable to QL-PRC / QL-PRS frequency source
135	T-BC	False	Holdover, within holdover specification, non-traceable to QL-PRC / QL-PRS frequency source
140	T-GM	True	Holdover, out of holdover specification, traceable to QL-PRC / QL-PRS frequency source
150	T-GM	False	Holdover, out of holdover specification, traceable to QL-SSU-A / QL-ST2 frequency source
160	T-GM	False	Holdover, out of holdover, specification, traceable to QL-SSU-B / QL-ST3E frequency source
165	T-BC	True False	Holdover, out of holdover specification
248	T-GM T-BC	True False	Without time reference since start-up
255	T-TSC	True False	Slave only OC (does not send Announce messages)

2. TESTING CHALLENGES

In any synchronization test set, there are at least five critical blocks or functions: the local oscillator, the clock reference, the network emulator, the test engine and the post processing unit. Each block involves its own challenges to test reliably and accurately:

- **Local oscillator:** The local oscillator constitutes an internal frequency source required by any

synchronization test equipment. The local oscillator is expected to be accurate within certain limits. It could theoretically be used as an autonomous (internal) reference but most of the time the local oscillator is locked to another clock reference. In this case, the local oscillator inherits some of the properties from the reference. A typical situation is to discipline the internal oscillator with a GNSS source. It is then expected that the local oscillator gets the long term frequency / time accuracy of the GNSS source.

- **Clock reference:** Sometimes, such as in jitter tests, the clock reference can be recovered from the signal under test by some kind of filtering processes, but more commonly the clock reference constitutes an independent input in the test. Two main alternatives are used in practical scenarios: *Primary Reference Clocks* (PRCs) / *Primary Reference Time Clocks* (PRTCs) and *Global Navigation Satellite System* (GNSS) signals.
- **Network emulator:** The test set has to be connected to a device or network to measure and, to some extent, it has to be compatible with the system where it is connected. Sometimes it is enough to achieve interface compatibility like with TDM or 1 PPS testing, but in other situations both interface and protocol compatibility is required. The most typical example of protocol compatibility is PTP testing that requires the test set to be interoperable not only with the physical interface (usually Ethernet and IP) but also with the PTP protocol itself. Specifically, most often, the test set has to implement some of the functionality of a PTP slave. It not only to decode timing information from remote PTP entities but also generate different kinds of PTP messages such as signaling messages and delay request messages.
- **Test engine:** The purpose of any test equipment is to measure and generate a result based on this measurement. In a synchronization tester the measurement, results consist of a sequence of numbers computed by comparing a relative or absolute time associated to the device under test and the time from the clock reference. For a typical wander measurement the test unit may generate several tens or hundreds test results per second. The exception to this rule is

jitter testing, as a high frequency phase impairment. Measurement bandwidth for jitter is in the range of kHz or beyond and it requires a different approach.

- *Post processing unit.* This building block computes synchronization performance metrics from the raw measurement results. Many impairment sources are either random or difficult to predict (variable waiting time in queues, oscillator noise, variations on GNSS coverage, temperature fluctuations). For this reason, the associated performance metrics are statistical in nature. Some common statistics are general purpose metrics like averages or standard deviations while some others have been defined specifically for synchronization applications such as the *Allan Deviation* (ADEV) or the *Time Deviation* (TDEV). Randomness of synchronization test results is a challenge in terms of repeatability. For example, estimations of the standard deviation of some kinds of phase noise does not converge to any specific value, even in very long tests; there is no way to measure (or even to define) an standard deviation for such processes. In other cases, the impairment processes involved in synchronization tests have a very low frequency (hours, days, weeks) or they are not periodic at all. Measurements involving non-stationary processes may be very long and even in this case may not be totally repeatable.

The Local oscillator

Synchronization testers are equipped with accurate (or not so accurate) local oscillators. The alternatives for this important component are described in the following lines.

In order to understand oscillators, it is useful to rate the accuracy of a standard wristwatch clock that has a quartz *Crystal Oscillator* (XO). The most intuitive way to qualify the accuracy of a clock is the fractional frequency offset measured in parts per million or other units. For the wristwatch the accuracy is on the order of 10 ppm (10^{-5}). We will see that there exist technologies that enable improvements many orders of magnitude better than this basic accuracy.

Table 5

Frequency accuracy of oscillators commonly used for Telecom applications

	Frequency accuracy
TCXO	2 ppm - 0.2 ppm
OCCO, DOCCO	10 ppb - 0.1 ppb
Rubidium	5×10^{-11} or better
Cesium	10^{-12} or better

Some crystals like quartz are capable of storing or supplying electrical energy depending on the mechanical stress applied to them. This is known as piezoelectricity and enables the crystal to couple mechanical and electrical vibrations. In practical terms, the crystal behaves like a tunable electrical circuit of a very high Q-factor.

The accuracy in these kind of oscillators is limited by the sensitivity to temperature changes in the crystal's natural oscillation frequency. *Temperature Compensated Crystal Oscillators* (TCXOs) have better performance in terms of temperature sensitivity. They are based on a *Voltage Controlled Crystal Oscillator* (VCXO) and a temperature sensitive circuit that applies a voltage that corrects the frequency of the VCXO at any temperature within the operating temperature range.

A different approach to temperature stabilization is implemented by *Oven Controlled Crystal Oscillators* (OCXOs). This type of oscillator has a temperature controlling circuit to maintain the crystal and key components at a constant temperature. *Double Oven Controlled Crystal Oscillators* (DOCCOs) are a refinement on the same technology that uses two separate heating circuits coupled together. DOCCOs are even better than OCXOs and their frequency accuracy could be a fraction of a part per billion (10^{-10}). The inconvenience of OCXOs / DOCCOs is that they are more expensive and they consume more power than TCXOs.

The accuracy of OCXOs / DOCCOs is the best that can be achieved through a piezoelectrically induced vibration. Increasing the performance requires using atomic clocks that use frequencies of specific electron state transitions of certain atoms or molecules. In the telecommunication industry two atomic frequency standards are commonly used. One is the Cesium atomic beam standard

that uses the transition between two ground levels of the hyperfine spectrum of the ^{133}Cs atom equivalent to 9,192,631,770 Hz. The second frequency standard is based on Rubidium vapor cells that use an hyperfine transition of the ^{87}Rb isotope to generate a frequency of 6,834,682,610.904 Hz.

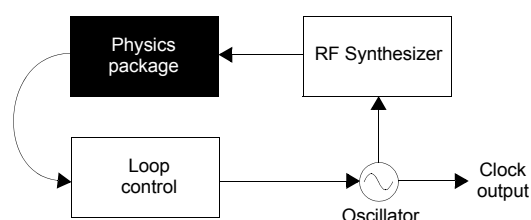

Figure 3 Simplified block diagram of an atomic clock. The feedback from the physics package is used to tune a conventional oscillator such as an OCXO.

The operation of an atomic clock is based on an interrogation-correction mechanism. A conventional crystal oscillator generates a frequency that is used to interrogate a “physics package” that contains the Cesium tube, the Rubidium vapor cell or any other device based on atomic resonances. The “physics package” generates an error signal that depends on the de-tuning of the test frequency from the atomic resonance. The error signal is processed and the result is used to control the frequency generated by the crystal oscillator that is also the clock output. The key piece of this setup is the “Physics package” that behaves like an extremely high Q-factor bandpass filter.

Aging effects are smaller in Cesium tubes than in Rubidium clocks. For this reason the Rubidium frequency standard is not suitable to operate in PRCs. However, Rubidium is well adapted for SSUs that are usually disciplined by a primary source or GNSS. These clocks are also perfectly suited to test applications due to their low power consumption, compact size and relatively low price. On the other hand, Cesium tubes may offer frequency accuracies of 10^{-12} or better and good long term frequency stability. These oscillators are therefore ideally suited to be installed in PRCs.

A special type of vapor cell atomic clock is the so called *Chip-Scale Atomic Clock* (CSAC). Current CSAC implementations have the advantages of low power consumption and short warm up period.

Performance in terms of fractional frequency accuracy is around 0.1 ppb, in line with the best available OCXOs.

Cesium tubes are by no means the best atomic clocks available today. Research in accurate time sources is a very active field and current accuracies achieved in new engines are in the range of 10^{-15} or better. Of the new techniques used to improve the performance of basic beam devices the most important is probably laser cooling of atoms. Using cold atoms reduces the contributions to error from the Doppler effect, atom collisions and thermal radiation, thus increasing the device accuracy by several orders of magnitude.

Clock References

The correct way to assess how good a clock reference is depends on the metric to be measured, the measurement bandwidth and, if disciplining is used, the local oscillator specifications. For example, in jitter tests the measurement bandwidth is usually in the kilohertz range. To get a valid clock reference it is enough to apply a 10 Hz low pass filter to the test signal. The filtered test signal is perfectly suitable to be used as a clock reference in a jitter test. If the measurement bandwidth is to be extended to lower frequencies, this mechanism becomes more difficult to implement because the cutoff frequency in the low pass filter has to be reduced beyond practical limits. In the wander tests, the bandwidth is in the millihertz or microhertz range. For this reason, the clock reference is an additional input to the test. The test signal phase is expected to be stable in the measurement bandwidth.

If we now focus on external clock references, there are three popular alternatives used in practical applications: PRCs, PRTC and GNSS references. This section deals mainly with PRCs and PRTCs. As the performance of GNSS references is strongly dependent on how they are used to discipline the local oscillator, these are discussed in a section devoted to oscillator disciplining.

For many years, the best clocks available for telecommunication applications have been PRCs. The PRC wander is described in ITU-T G.811 in terms of three interface independent metrics: The *Maxi-*

imum Time Interval Error (MTIE), the Time Deviation (TDEV) and fractional frequency offset. Actually, the specification for the fractional frequency offset is embedded in the MTIE and therefore all that can be said about the PRC wander is packaged in specifications for MTIE and TDEV. There is a lot to be explained about MTIE and TDEV but in simple terms, the MTIE defines the maximum phase excursion within an observation window and the TDEV measures the stability of a clock source in the given observation window. Both the MTIE and TDEV depend on a time parameter, the observation window. Because of this, their limits are expressed through masks specified in terms of a variable observation window. Unlike MTIE and TDEV, the fractional frequency offset is just a number, 10^{-11} for a PRC. We have seen that Cesium beams are able to achieve this accuracy level.

any specification about locked or holdover performance. PRCs are expected to always work in a free running state.

ALBEDO Telecom - Registered in Barcelona. Book 41613, Page 155, Sheet B-390886 - VAT : ESB6523022

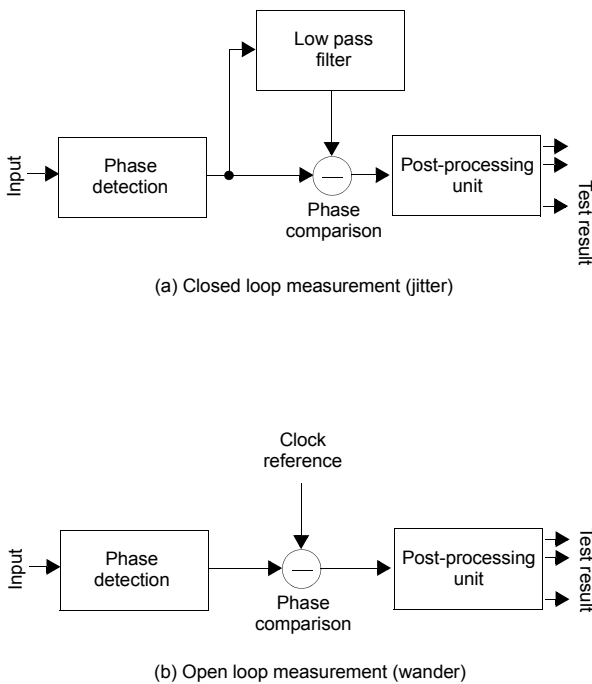

Figure 4 Simplified block diagrams of a jitter and a wander test equipment. (a) Closed loop measurement typical of jitter measurements. (b) Block diagram corresponding to an open loop test required to measure wander.

PRCs are not expected to be locked to any external reference. They are devices designed to provide synchronization but they are accurate enough to not require synchronization to an external reference. For this reason, ITU-T G.811 does not contain

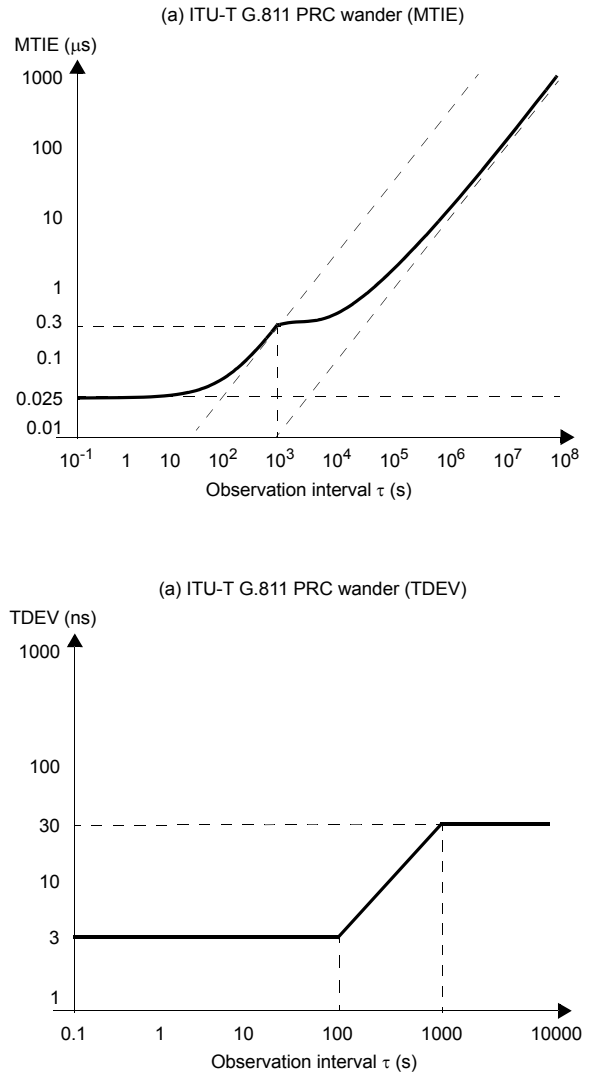

Figure 5 ITU-T G.811 performance limits of a PRC expressed in terms of MTIE and TDEV.

A PRC locked to a time reference with a good long term accuracy, typically derived from a GNSS interface, is a possible realization of a PRTC. While PRCs are frequency references, PRTCs are designed to provide time outputs. Sometimes, PRTCs have 1 pulse per second (1 PPS) / Time of Day (ToD) outputs which can be used to feed other devices requiring accurate time synchronization but often the PRTC function is packed together with a PTP grandmaster; it is quite common to see commercial PTP grandmasters with one or several GNSS in-

puts. Before addressing the detailed description of PRTC, it is worth looking at time references and their properties more carefully.

A time reference is made up of an (accurate) frequency reference plus a counting device that increases as new cycles in the frequency reference are recorded. Actually, as it would be impractical to count cycles one by one, the standard time unit is defined to be an integer number of cycles taken from a specific frequency reference. For the *second*, the frequency reference is the same atomic transition from the ¹³³Cs that is used in Cesium-beam atomic clocks. One second is thus defined to contain exactly 9,192,631,770 cycles of this atomic reference.

Table 6
Commonly used time Scales

Time Scale	Definition
TAI	International Atomic Time. Weighted average of the time kept by about 200 atomic clocks in over 50 national laboratories worldwide.
UTC	Coordinated Universal Time. Atomic scale compensated by an integer number of seconds so that the difference with UT1 is less than 0.9 seconds.
UT0	Uncorrected UT as derived from astronomical observations or from measurements carried out from the GPS system.
UT1	UT0 corrected for the polar motion of the Earth.
UT2	UT1 corrected for the regular slowing down and speeding up of the Earth in winter and summer. It is now considered obsolete.
GPS time	This time scale was designed to match UTC in the period from 1980-01-01 to 1981-06-30 but as no leap seconds have been added since that date, the GPS time is now (2016) 17 seconds ahead UTC and 19 seconds behind TAI.

The specification of the time reference must also contain an origin or epoch. The epoch is defined as the point of time that contains zero units of time. The specification of the time unit, together with the make up a time scale. It can therefore be concluded that a time reference is a frequency reference with a specific time scale.

Table 7
Leap seconds added

UTC Date	Amount	TAI to UTC offset
1972-06-30	+1 second	11 seconds
1972-12-31	+1 second	12 seconds
1973-12-31	+1 second	13 seconds
1974-12-31	+1 second	14 seconds
1975-12-31	+1 second	15 seconds
1976-12-31	+1 second	16 seconds
1977-12-31	+1 second	17 seconds
1978-12-31	+1 second	18 seconds
1979-12-31	+1 second	19 seconds
1981-06-30	+1 second	20 seconds
1982-06-30	+1 second	21 seconds
1983-06-30	+1 second	22 seconds
1985-06-30	+1 second	23 seconds
1987-12-31	+1 second	24 seconds
1989-12-31	+1 second	25 seconds
1990-12-31	+1 second	26 seconds
1992-06-30	+1 second	27 seconds
1993-06-30	+1 second	28 seconds
1994-06-30	+1 second	29 seconds
1995-12-31	+1 second	30 seconds
1997-06-30	+1 second	31 seconds
1998-12-31	+1 second	32 seconds
2005-12-31	+1 second	33 seconds
2008-12-31	+1 second	34 seconds
2012-06-30	+1 second	35 seconds
2015-06-30	+1 second	36 seconds

Historically time scales (the calendar) have been based in astronomical observations. *Universal Time* (UT) is based in the concept of mean solar day. The *Ephemeris Time* (ET) uses certain astronomical events that are supposed to happen at regular intervals. The accuracy of the UT is limited because of irregularities in the Earth's rotation. The Earth's rotation axis and speed are known to change with time and different adjustments to UT time are necessary in order to maintain accuracy. That's the reason there are UT0, UT1 and UT2 time scales depending on the correction added to account for these irregularities. Being independent of the Earth's rotation, ET is more accurate. Actually, the definition of a second based on ET replaced the definition based on the mean solar day in 1956 and was used until 1967 when it was replaced by the atomic second. The main drawback of ET is that it is

necessary to wait for astronomical events to happen to adjust the time. Atomic time is readily at any time.

Time scales based on astronomical observations were replaced by time scales based on atomic time at the end of 1950s. *Coordinated Universal Time* (UTC) is an atomic time scale defined to match the UT2 time (and later UT1) within a certain error margin. Before 1972 the adjustment mechanisms included slight modifications in the standard second length and small phase adjustments of 1/10 of second. From 1972 onwards the *leap second* mechanism was agreed upon; through this mechanism, one day (always chosen to be January 1st or June 30th) is allowed to have one more or one less second than an standard day. The leap second mechanism has been applied 26 times to compensate for the offset measured from UT1. Closely related with the UTC time scale, there is the *International Atomic Time* (TAI) scale which is exactly the same as UTC time but it contains no leap seconds. The TAI time was adjusted 10 seconds ahead of UTC at the beginning of 1972. This means that the current offset (2016) is 36 seconds. This difference accounts for the slow down of Earth's rotation in the last half century.

A full description of the epoch in use for different time scales would be quite complex. For our purposes it is enough to state that PTP uses the TAI time scale and the epoch is 00:00:00 01/01/1970. This selection is done so that the POSIX algorithm applied to the PTP 0 seconds time stamp gives the date and time mentioned before. PTP also allows the use of arbitrary time scales to account for network administrators willing to use a different epoch. The GPS system starts counting time from 00:00:00 06/01/1980 (6th of January) but as no leap seconds applied to the GPS time, this time scale is currently 17 seconds ahead of UTC.

Specification of a PRTC is the subject of ITU-T G.8272. Unlike PRCs, PRTCs are expected to be disciplined by at least one time reference. For this reason, PRTC specifications are given not only for free running status but also for locked and holdover. When locked to a GNSS or other reference, the PRTC specifications are almost identical to the PRC but the requirement about fractional frequency

offset is replaced by a new requirement for *Time Error* (TE). Specifically, the total TE is expected to remain under 100 ns for the entire test duration.

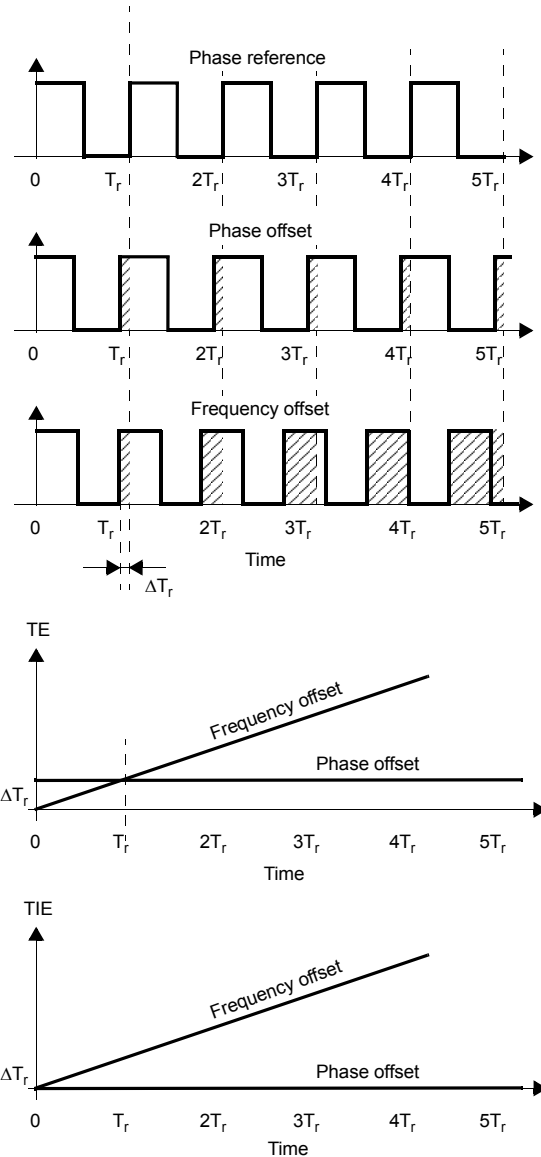

Figure 6 Differences between TE and TIE. The TE is the difference between two times and the TIE is the difference between two time intervals

The TE is the performance metric typical of time sources. It is defined in ITU-T G.810 as the difference between a given time and a reference time, both expressed in the same time scale. TE is defined so that it is positive if the test signal is ahead of the reference and negative otherwise. The TE is to be compared with the *Time Interval Error* (TIE). While the TE is the difference between two absolute times, the TIE is the difference between two time intervals and it is therefore a relative metric

independent of the epoch. The TIE is very useful performance metric for frequency deployments (the MTIE and TDEV are derived from the TIE) but in time and phase applications the TIE has to be replaced by the TE.

The $|TE| < 100$ ns requirement is related with a further $MTIE < 100$ ns limit (the opposite is not true, an $MTIE < 100$ ns limit does not necessarily require the TE to be under 100 ns). Actually, the ITU-T G.8272 MTIE mask is the intersection of the $MTIE < 100$ ns region and the ITU-T G.811 PRC mask. The TDEV requirement is exactly the same for a PRC and a PRTC. From this point of view, it can be said that the PRTC requirements are stronger than the PRC operation limits but it must not be forgotten that PRTCs are specified when they are operating in locked status and PRCs are specified in free running status. The requirements for both are thus not directly comparable.

Oscillator Disciplining

A synchronization test set is expected to measure the performance level of accurate timing sources such as Cesium PRCs that are often used to supply synchronization to large networks. The question is, how can a synchronization tester measure the accuracy of a clock that is potentially much better than its own local oscillator? This is done through an external reference, or still better, by a combination of an external reference and the local clock achieved through a process known as oscillator disciplining. Even with oscillator disciplining it is not uncommon that the test signal is of the same nominal accuracy level as the local (disciplined) oscillator. A typical example is the measurement of a PRC using another PRC clock reference. In this case, a pass result is certainly reliable but the same cannot be said about a fail because there is no way to separate the phase / frequency degradations in the test signal and in the reference. As a result, we must be prepared for uncertain results in telecom synchronization tests.

In test applications, it is quite common to use GNSS to discipline a Rubidium or an OCXO local oscillator. It is a notable fact that none of the Rubidium / OCXO or GNSS references alone are compliant with ITU-T G.8272 but a carefully de-

signed Rubidium / OCXO oscillator locked to a GNSS reference may be perfectly suitable to operate as a PRTC.

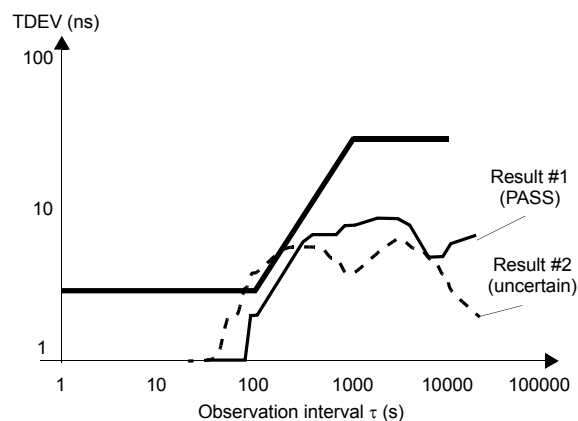

Figure 7 Two real test results run at the output of the same PRTC. Compliance with the ITU-T G.8272 TDEV mask is verified. One test is pass the other is uncertain.

It is a common misunderstanding to think that a GNSS input alone may behave as a primary reference source. GNSS modules provide time references in the form of 1 PPS / ToD outputs but these are not explicitly visible. We can therefore think about GNSS references as special kind of 1 PPS / ToD interface and we can measure the performance of the GNSS module in terms of TE, MTIE and TDEV in the same way we do for other 1 PPS interfaces. If we could measure the output from the GNSS module, we would see many short and medium term variations and strongly jittered pulses. The amplitude of GNSS derived phase fluctuations could easily reach tens of nanoseconds but on the other hand the output exhibits very good long term stability based on the accuracy from GPS, GLONASS or other satellite constellations.

With Rubidium / OCXO references it happens to be the opposite: they are stable in the short term but they drift when they are free running. By disciplining the Rubidium / OCXO with the GNSS, the local oscillator inherits the long term frequency accuracy from the satellite system while keeping good performance in shorter observation windows. Moreover, with the disciplining process, the local oscillator gets a time scale and thus becoming a time source. If the design is good enough, the TE of the disciplined clock can be made smaller than

100 ns and the MTIE and TDEV could be constrained within the ITU-T G.8272 pass region. The disciplined oscillator then effectively becomes a PRTC.

Using the GNSS receiver in the best possible way is important for wander result accuracy. The first point to be considered is the antenna. Fixed antenna installations tend to offer better performance than small portable GNSS antennas. There are at least three operation conditions to be considered:

1. Proper operation requires the antenna to see the largest possible portion of the sky to receive a signal from as many satellites as possible.
2. Multi-path signal propagation caused by close buildings or other elements may damage the GNSS signal quality and it should be avoided.
3. Signal strength is also important. If necessary, the GNSS signal has to be amplified before it is injected into the receiver.

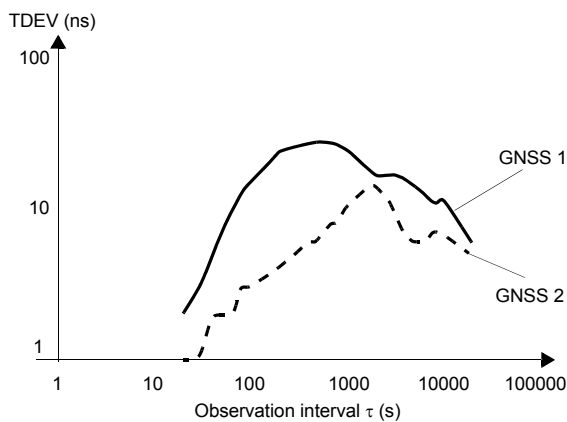

Figure 8 The same TDEV measurement carried over with two different GNSS references and the same local oscillator (an OCXO).

The receiver itself is also important. A general purpose GNSS receiver can be used but it is probably a better choice to use a receiver specifically designed for timing applications.

One of the most important differences between Rubidium and OCXO oscillators is the way they behave when they are locked to a GNSS reference. The longer the time constant corresponding to the

filter applied to the GNSS reference the better the ability to remove undesired drift from the reference. To be efficient, the local oscillator has to be stable during a period equivalent to the filter time constant. Rubidium oscillators remain stable for much longer times than OCXOs and therefore their ability to filter the GNSS reference is larger.

The second advantage of Rubidium oscillators and other atomic time / frequency references is the ability to operate in holdover mode for long periods of time. As a general figure, the error in TE estimations due to the drift of a Rubidium reference in holdover could be smaller than 100 ns in a two hour test and smaller than 1000 ns in a 24 hour test. OCXOs have a very limited holdover capability. Typical phase errors after a holdover period of two hours is 1 μs or more. For this reason, OCXO are almost of no use for long MTIE and TDEV tests with no external reference.

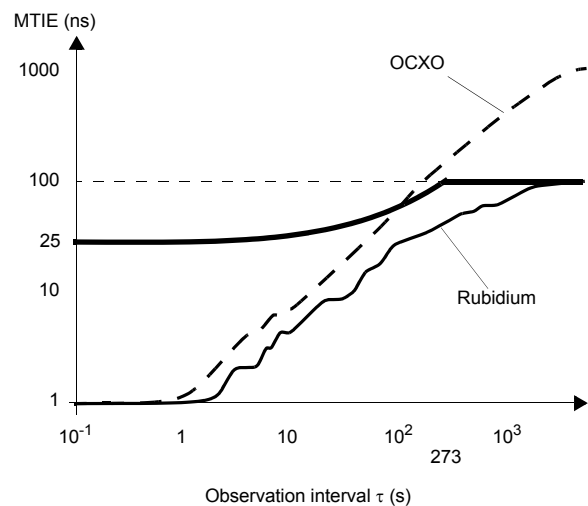

Figure 9 Rubidium and OCXO holdover performances in a 2 hour MTIE test. Both tests have been run at the output of a PRTC. Only the Rubidium gives a pass result. The OCXO measures an MTIE larger than the mask for observation windows longer than 2 - 3 minutes.

Most of the discussion about oscillator disciplining has been focused on Rubidium / OCXO disciplining with GNSS but this is by no means the only possibility. Virtually any reference could be used to discipline an oscillator. Using a 1 PPS / ToD reference is also a popular alternative and disciplining to a fre-

quency reference (either periodic such as 1544 kHz, 2048 kHz or 10 MHz or non-periodic such as 1544 kb/s 2048 kb/s) is possible as well.

Table 8

Performance level of different combinations between clock references and local oscillators

	TCXO	OCXO	Rubidium
PRC (frequency ref.)	High	High	High
PRTC (1 PPS / ToD ref)	Low	High	High
GNSS	Low	Medium	High

Disciplining to 1 PPS / ToD references has many similarities with GNSS disciplining. The main difference is that 1 PPS / ToD may be the output of a high performance network clock such as a PRTC. These signals are normally “cleaner” than GNSS references and therefore they do not require the same level of sophisticated filtering applied to GNSS inputs. An important point about 1 PPS / ToD references is that they are slow signals. They can be used to adjust the local oscillator only once per second, which is the 1 PPS frequency. The local oscillator must remain stable during the time period between two consecutive adjustments (1 second). This is applicable to Rubidium oscillators and OCXOs but not TCXOs. Frequency references can be used with all kinds of local oscillators, including TCXOs but they cannot be used for time and phase applications, unfortunately.

3. BASIC TESTING SCENARIOS

Synchronization tests may be classified as emulation and monitoring tests. In an emulation test, the test set behaves as specific network element (or a group of elements) and sometimes it replaces this entity. Usually the test set is not required to replicate all the functionality of the emulated equipment, but on the other hand the tester is able to carry out some diagnostics that are beyond the emulated equipment capabilities. As an example, a test unit may be unable to manage hundreds of simultaneous unicast PTP sessions but it may carry out advanced TE, MTIE and TDEV tests over a reduced set of these sessions. The purpose of a monitoring test is to get information about the tested

entities without disturbing them. A network monitor should not generate any traffic and it should not disturb existing traffic. It must rely on the traffic captured from the devices under test through one or various interfaces.

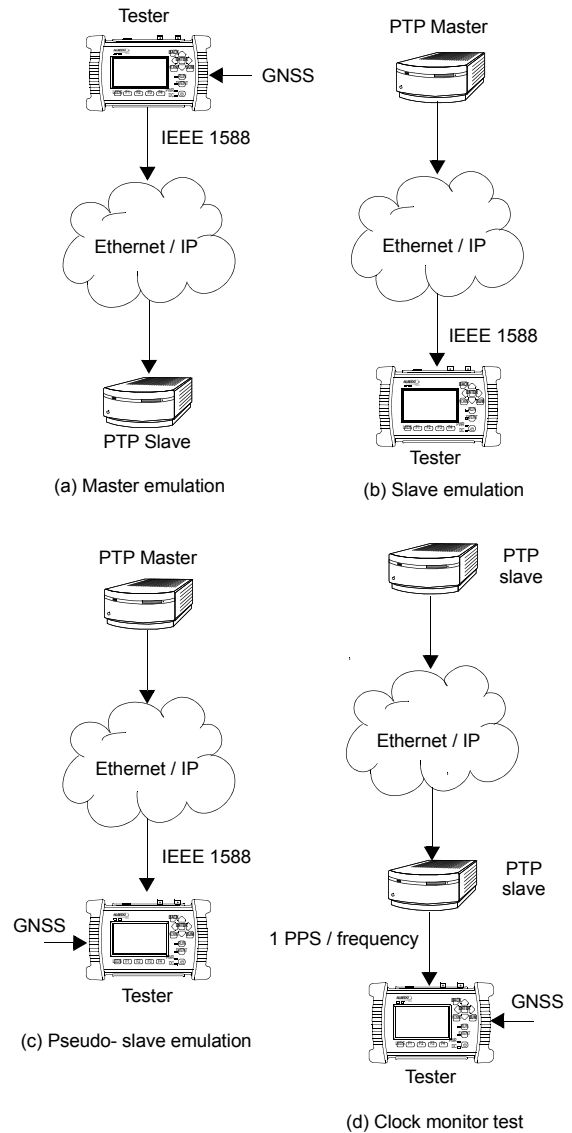

Figure 10 Basic PTP testing scenarios in endpoint mode: (a) Master emulation mode, (b) Slave emulation mode, (c) Pseudo-slave emulation mode, (d) Clock monitor mode

Many PTP tests could be run both in endpoint or in monitoring modes, but generally, gathering the data required to compute all the important performance metrics is more difficult in passive monitoring mode because the tester has to intercept various PTP message flows including the mas-

ter-to-slave and slave-to-master transmission directions. Monitoring also assumes that there is a network already in operation, which may not be always true. On the other hand, active endpoint emulation may disturb the network but due to the small amount of traffic involved this is not significant most of the time and access to the testing data is more straightforward in this case. An advantage of active synchronization testing is the possibility to generate background traffic to see how the network reacts under specific load conditions. For all these reasons, this paper focuses mainly on active testing.

Depending on the equipment connected to the network and the entity being emulated there are four basic test setups:

1. **Master emulation:** The test unit replaces a PTP master. The main purpose of this operation mode is not to do any measurement but to stress the network, including the slave. Actually, in this mode, the test unit only receives delay request messages (in some profiles, the path delay mechanism may be disabled and therefore not even delay request messages are received), which do not carry enough information to do any detailed performance analysis. The basic application of the master emulation mode is to verify that remote slaves are capable of communicating smoothly with the master. This mode could be used to see how the slaves respond to some uncommon operation conditions: processing of TAI and arbitrary time scales, interworking with 1-step or 2-step clocks, behaviour under different time and frequency traceability conditions, conformance with different message rates and the ability to process leap second events. The ability to generate simultaneous PTP and background traffic requires special mention. This is important to check the tolerance to high traffic conditions in the slave and other PTP-aware or non-PTP-aware network elements. The master emulation mode could also be applied to Synchronous Ethernet and other physical layer synchronization technologies, but in this case background traffic generation becomes irrelevant. The ability to generate wander signals to verify how the phase impairments are accumulated is still an important feature though.
2. **Slave emulation:** In this case, the slave is

replaced by the test unit. The tester processes the information received from the master and it tries to track the timing signal in the same way as any other PTP slave clock. This operation mode can be used to get message statistics, verify basic conformance and to get some PDV metrics such as the packet delay variance, standard deviation and range. The slave emulation mode is not suitable for more sophisticated performance tests involving MTIE, TDEV and TE. It is difficult to measure MTIE and TDEV in this mode because the test unit is disciplined by a device that is at the same time the device under test. This means that in the long term all recorded phase fluctuations are zero and gives unrealistic MTIE and TDEV results. In other words, test unit configured in slave emulation behaves as a low-pass filter; it absorbs slow phase fluctuations and it filters out fast impairments. For this reason, higher frequency phase fluctuations are the only ones that can be detected in this mode. The explanation for the limitation to measure TE is different and more involved. IEEE 1588 slaves assume that they are operating over symmetrical transmission media. Specifically, IEEE 1588 slaves run an iterative algorithm to minimize the path delay asymmetry. In a steady, noiseless channel the asymmetry will always be close to zero in slave emulation mode. A different kind of test available in slave emulation mode is the background traffic generation test. The purpose of this test is the same that in master emulation mode but in this case the background traffic flows in the slave-to-master direction.

3. **Pseudo-slave emulation:** This mode is similar to the slave emulation mode but now the test unit keeps an independent synchronization source. Typically, a GNSS reference is used but the test equipment could use any other reference such as 1 PPS / ToD, frequency inputs or even an internal oscillator in holdover / free running states. From the outside, the pseudo-slave and slave emulation modes are indistinguishable but internally they are different. Now the reference and test signals can be compared and the measurement bandwidth could be extended to very low frequencies involving phase variations of hours or days typical of

MTIE and TDEV tests. If a time reference is used (1 PPS / ToD, GNSS) the TE could be computed as well. Finally, the pseudo-slave operation mode is also compatible with background traffic generation. This feature could be used to check any change in the TE, MTIE and TDEV depending on the traffic load.

4. *Clock monitor*: It is good for a test set to support at least some kind of passive test mode. This mode could be the monitoring of clock interfaces. Monitored signals should include both frequency (2048 kb/s, 2048 kHz, 1544 kb/s, 1544 kHz, 10 MHz) and time (1 PPS). The performance metrics in these interfaces are similar to that in Ethernet / IP ports. Traditional MTIE and TDEV are used rather than their versions for packet interfaces and TE could be reused almost with no modification. Clock monitoring tests run over the clock recovered by some network equipment, typically a PTP slave. This is conceptually different to a PTP test run directly over the packet interface. It is a good idea to compare results from a 1 PPS / frequency output in the slave and the packet test to qualify the slave. Some of the main disadvantages of clock monitoring are the lack of active traffic generation in this mode and the difficulty to access some key statistics about latency, path delay asymmetry and delay dispersion.

Table 9

Comparison between packet and clock monitoring tests

	1 PPS	IEEE 1588
Message exchange statistics	No	Yes
Latency and asymmetry	No	Yes
Ethernet / IP traffic statistics	No	Yes
Master / slave emulation	No	Yes
Background traffic generation	No	Yes
TE	Yes	Yes
MTIE, TDEV	Yes	Yes
Floor delay population	No	Yes

Strictly speaking, virtually all commissioning tests required in both frequency and time distribution deployments could be done in clock monitor mode. Clock interfaces are good enough if all that is required is to qualify the network to support specific PTP profile, but the information they supply is

quite limited for troubleshooting applications. While the description of commissioning tests is addressed in several standards such as ITU-T G.8261.1 and G.8271.1, troubleshooting is largely forgotten by the main standardization bodies, but advanced testing carried out at different points in the distribution and access networks is essential for these kinds of applications.

4. VERIFICATION OF FREQUENCY DISTRIBUTION DEPLOYMENTS

It has already been stated that ITU-T G.8261 and G.8261.1 extend the applicability of ITU-T G.823 and G.824 to packet switched networks. With this purpose in mind, these standards define two new kinds of network clocks, the EEC and the PEC. PECs may refer to NTP or PTP clock equipment. Both the EEC and the PEC are expected to interwork with other synchronization network entities such as PRCs, SSUs or *SDH Equipment Clocks* (SECs) (following the ANSI terminology, *Stratum 1*, *Stratum 2* and *Stratum 3* entities). More specifically, in a frequency distribution deployment we can find three different kinds of technology:

- *TDM synchronization equipment*: Includes all equipment related with SDH / SONET synchronization. This equipment commonly has synchronization inputs and outputs based on the 2048 kb/s and 1544 kb/s interfaces.
- *Synchronous Ethernet equipment*: Synchronous Ethernet could be understood as a mixture between TDM and packet synchronization. It is a technology that works in the same way as TDM synchronization but it operates in an Ethernet interface. It is capable of supplying potentially the same performance level as TDM synchronization. One Synchronous Ethernet drawback is that it requires on-path support. TDM synchronization and Synchronous Ethernet are the two existing L1 synchronization technologies.
- *Packet-based Synchronization equipment*: Packet based synchronization protocols carry the timing information in departure / arrival times of certain protocol messages and in time stamps carried by these or other messages. Packet based synchronization is independent of

the physical transmission layer. The most important packet based synchronization protocols are PTP and NTP but this document deals exclusively with PTP, by far the most accurate of the two. PTP works better with on-path support but it may work without it. This is a big advantage if packet based synchronization is to be deployed in existing networks.

Verification of frequency distribution deployments in packet switched networks is pretty much the same as in circuit switched networks. Most operation limits and masks are re-used and some others are only slightly modified. For example, the fractional frequency accuracy for a PRC is 10^{-11} and a free running SSU (ITU-T G.812 Type I clock) has frequency accuracy of 16 ppb or better. These are almost psychological operational limits to rate the operational performance of network clocks. These limits are still relevant in packet switched networks.

Table 10

Performance limits in frequency distribution applications

Interface	Limit (ITU-T)
TDM network	G.823, G.824
TDM equipment	G.811, G.812, G.813
Synchronous Ethernet network	G.8061
Synchronous Ethernet equipment	G.8062
PTP network	G.8261, G.8261.1
PTP equipment	G.8263

Standards define performance limits both for isolated devices and for networks. The limits we have studied for PRCs and PRTC are examples of device operation limits but no specific limit for networks has been described so far. The next paragraphs deal with this subject. The main reference for Synchronous Ethernet network operation limits is ITU-T G.8261. Limits for packet-based networks are described in ITU-T G.8261.1.

Synchronous Ethernet

Synchronous Ethernet is an ITU-T standard that provides mechanisms to transfer frequency over the Ethernet physical layer or L1, which can then be made traceable to an external source such as a network clock. As such, the Ethernet link may be used

and considered part of the synchronization network. Currently, Synchronous Ethernet is seen as an important building block for accurate frequency over packet switched network. A limitation of Synchronous Ethernet is the inability to transfer time. It can be used only for frequency synchronization.

A key topic in Synchronous Ethernet is the definition of the mechanisms necessary to achieve interworking between SDH / SONET and Ethernet equipment. These mechanisms and procedures are found fundamentally in three different recommendations: ITU-T G.8261, G.8262 and G.8264:

- Extension of the synchronization network to include Ethernet as a building block (ITU-T G.8261) enables Synchronous Ethernet network equipment to be connected to the same synchronization network as SDH / SONET. Synchronization for SDH / SONET can be transported over Ethernet and the opposite is also true.
- ITU-T G.8262 defines the EEC to be compatible with other SDH clocks. EECs are based on ITU-T G.813 clocks and they are defined in terms of accuracy, noise transfer, holdover performance, noise tolerance, and noise generation. While the IEEE 802.3 standard specifies Ethernet clocks to be within ± 100 ppm ITU-T G.8262 specifies EEC accuracy to be within ± 4.6 ppm. Additionally, PRC traceability of the interface is achievable by disciplining the EEC.
- ITU-T G.8264 extends the usability of the ITU-T G.781 SSM by Synchronous Ethernet equipment. The SSM contains an indication of the quality level of the clock that is driving the synchronization chain. The *Ethernet Synchronization Message Channel* (ESMC) is used for propagation of the SSM through the Synchronous Ethernet network.

The basic difference between a conventional Ethernet and a Synchronous Ethernet network interface card is that the Synchronous Ethernet card is prepared to accept external timing or to supply timing to other subsystems. On the other hand, the conventional card is relegated to operate with its own ± 100 ppm internal clock. Note that the conventional card is still able to use the clock from an external subsystem (for example the CPU) for data transmission but data reception is not coupled to the transmitter clock and it is also uncoupled to

other transmitters in the network. This last feature is the one that defines IEEE 802.3 Ethernet as an asynchronous technology.

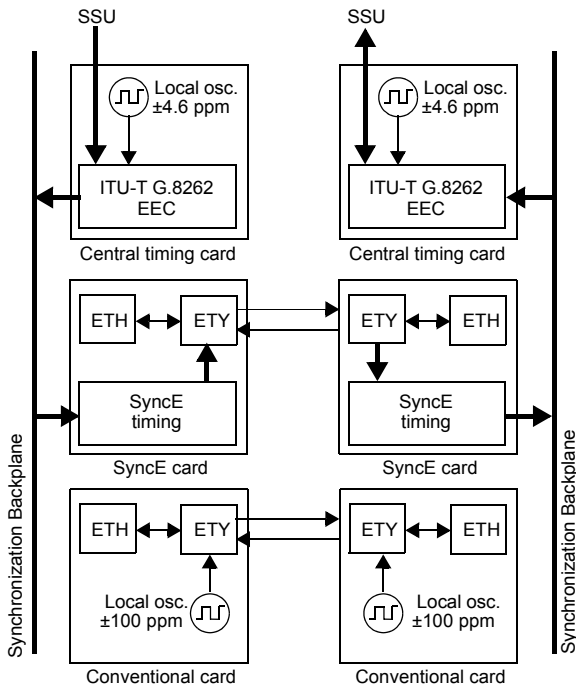

Figure 11 Synchronous Ethernet Architecture and comparison with conventional Ethernet

Synchronous Ethernet’s ability to accept or give timing signals makes this technology suitable for hierarchical synchronization. Here, the key element is the EEC which enables Ethernet nodes to accept or supply synchronization to other Ethernet or TDM equipment. Thanks to this property, Synchronous Ethernet becomes a new building block of the synchronization network.

MTIE and TDEV

MTIE and TDEV are the most important performance metrics in Synchronous Ethernet and PTP frequency distribution deployments. If there are fractional frequency offset requirements, these can be built into the MTIE mask.

MTIE and TDEV network limits for Synchronous Ethernet are given in ITU-T G.8261. MTIE and TDEV are computed in the same way as in any TDM inter-

face but the Synchronous Ethernet test is carried out over a 1000BASE-T, 1000BASE-X or any other Ethernet interface compatible with this technology. Actually, ITU-T G.8261 extends the applicability of ITU-T G.823 and G.824 to Synchronous Ethernet. Performance of Synchronous Ethernet deployments do not depend on the load and therefore the measurement could be run without worrying about traffic conditions.

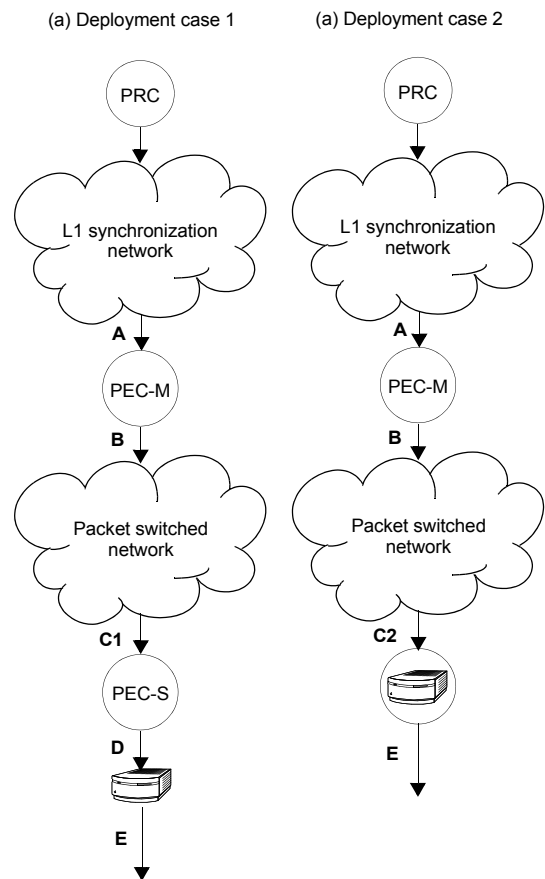

Figure 12 (ITU-T G.8261.1 reference model for frequency distribution applications. It includes both L1 synchronization and packet-based synchronization.

For packet synchronization the situation is quite similar. Different limits apply if the packet network is to totally or partially replace a TDM segment or if packet synchronization is to be used to deliver timing to specific application. In the former situation, packet synchronization is expected to provide the same performance as Synchronous Ethernet and therefore the same operational limits in terms of MTIE and TDEV apply. If packet synchronization is

aimed to deliver timing to specific applications, then the limits are given by the application requirements themselves.

of different technologies (TDM, Synchronous Ethernet, etc). MTIE and TDEV are expected to be measured in non-packet interfaces.

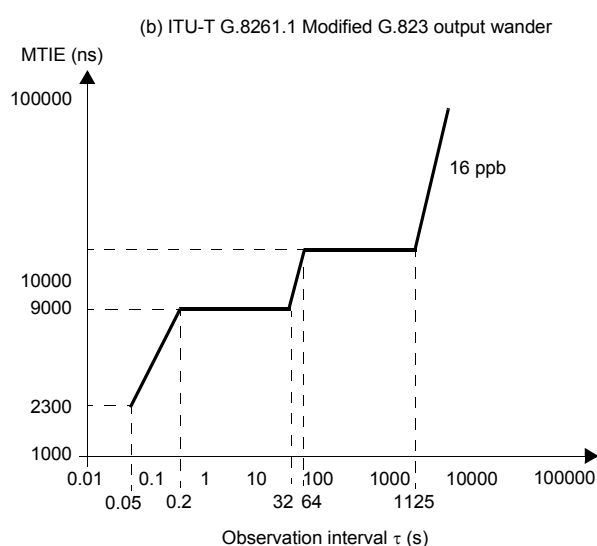
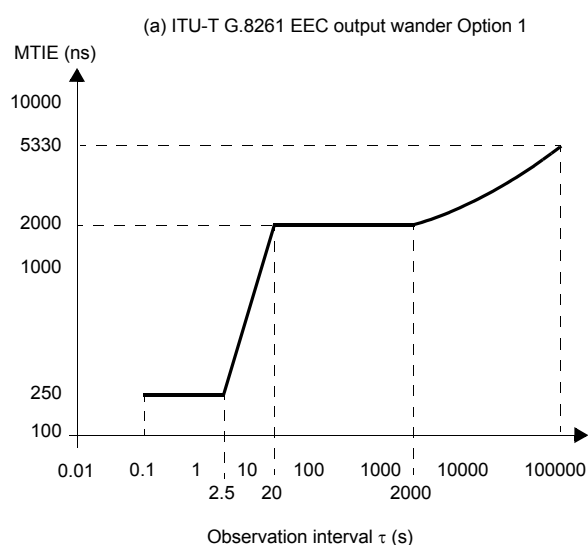

Figure 13 (a) ITU-T G.8261 EEC output wander option 1. Applies to the output of an EEC-1 but also may apply to a PEC-M and PEC-S. (b) ITU-T G.8261.1 modified ITU-T G.823 mask that applies to PEC-S output.

When PTP (or NTP) is used to supply frequency synchronization to a remote application the limits from ITU-T G.8261.1 may apply. This standard defines reference models for frequency delivery deployments, reference test interfaces, performance metrics and operation limits based on these metrics. Some of the reference test interfaces are packet based and some others may be based on a number

This is a summary of the ITU-T G.8261.1 operational limits in terms of MTIE and TDEV:

- *Network limits applicable at the input of the PEC-M (Reference point A):* If the PEC-M is synchronized through a network, then the operation limits from that network apply at the PEC-M input. For example, if the network is Synchronous Ethernet the limits from ITU-T G.8261 apply. If the network is TDM, then the limits from ITU-T G.823 / G.824 apply. If there is no synchronization distribution network and the PEC-M is directly connected to a PRC then ITU-T G.811 applies.
- *Network limits applicable at the output of the PEC-S (Reference point D):* Again ITU-T G.8261 applies when the PEC-S output is Synchronous Ethernet. If the output is 2048 kb/s, the performance in terms of MTIE is provided by a modified mask that results from the intersection of the ITU-T G.823 2048 kb/s mask for traffic interfaces and the 16 ppb MTIE straight line. These measurements are to be done over the PEC-S recovered clock.

Despite being defined for a packet network, the PEC-M and PEC-S limits are given in terms of traditional TDM metrics. For example, there is no requirement at the output of the PEC-M. In some deployments, reference point D may not exist. Then, if ITU-T G.8261 is literally followed there is only one wander measurement to be run, the one at the input of the PEC-M!

Network operators willing to improve the control they have on the network performance may be interested in running at least two more tests. One at the output of the PEC-M (reference point B) and a second one at the input of the PEC-S (reference point C). The traditional MTIE and TDEV metrics could not be reused here but they could be replaced by the *pkfilteredMTIE* and *pkfilteredTDEV*, both defined in ITU-T G.8260. In some respects, the *pkfilteredMTIE* and *pkfilteredTDEV* behave like packet interface equivalents of MTIE and TDEV. The main difference being that the packet metrics require the input sequence to be preprocessed.

Packet preprocessing is necessary to avoid unnecessarily pessimistic results. Raw TE samples contain a certain amount of PDV that is easily filtered out. Packet preprocessing is defined in ITU-T G.8260 and it consists of two filters to be applied sequentially to the raw TE:

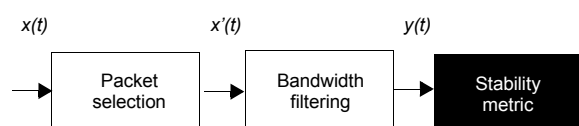

Figure 14 ITU-T G.8260 *pkfilteredMTIE* and *pkfilteredTDEV* preprocessing.

- **Packet selection:** It is a non-linear filter that samples the TE sequence looking for values in specific ranges to highlight certain properties in the result. For example, packet selection could be used to discard packets with a potentially high amount of delay variation. These values are then eliminated before they can be averaged with more accurate samples and degrade result accuracy.
- **Bandwidth filtering:** The bandwidth filter is a linear averaging filter. This filter removes high frequency impairments in the signal under analysis so that only slow variations are taken into account.

Floor Delay Population Test

Floor Delay Population is the only real packet metric required for frequency deployment commissioning. The floor delay population test attempts to implement a mechanism to measure the number of synchronization messages suitable for slave synchronization. With this objective in mind, the test defines an acceptable end-to-end delay range. The lowest delay is defined to be the floor delay for the path under test. In other words, it is the smallest latency recorded for a packet as it is transmitted through the test path. The highest delay allowed is obtained by adding a fixed time to the floor delay. Samples are rated as conforming if they are found between the minimum and the maximum allowed delay values. Non conforming packets exhibit an

end-to-end delay larger than the maximum. By definition, there are no packets with end-to-end delay below the floor delay.

The acceptable delay range given in ITU-T G.8261.1 at the input of the PEC-S (reference point C) is 150 μ s. It is expected that at least 1 % of the synchronization messages will fall into this range for any 200 s observation window. As the expected delay variation generated in most currently available PEC-M is in the range of nanoseconds, it can be concluded that degradation in frequency deployments is expected to happen due to variable delay in network elements.

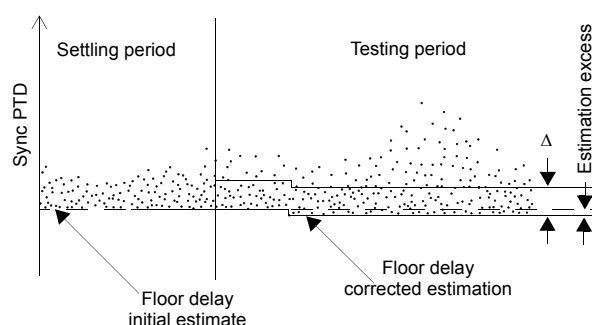

Figure 15 Illustration of the floor delay population test. Samples are classified as conforming or not conforming depending on the latency the experience from the grandmaster computed from the floor delay.

As a performance metric, the floor delay population has several inconveniences which limit its applicability:

- It depends on one-way delay computations and it therefore requires an external clock reference. Actually, the measurement does not require a time / phase external clock but at least a frequency reference is necessary.
- It requires knowledge of the minimum path delay or floor delay. The floor delay could be a test input parameter or it could be computed in a training period before the start of the real test. If the network is not stationary the floor delay may be difficult to compute. If the floor delay changes during the test (due to re-routing for example) results may not be accurate.
- In many deployments the Floor Packet Percentage is just 100%, which means that all messages have been received within the 150 μ s range required by the standard. This is a clear pass re-

sult but it gives no more insight about the way the network is behaving. It is always possible to run the test with a different delay range but this requires previous knowledge of the network performance.

Due to the floor delay population test limitations it is interesting to consider some complementary performance metrics available in frequency distribution deployments. Among these metrics we can highlight the classical dispersion metrics, which in this case have to be estimated over the delay probability density function. Some of the most important statistical dispersion metrics are the variance, standard deviation and range. None of them require of an external reference, pre-testing training periods or previous knowledge about network performance.

5. VERIFICATION OF TIME DISTRIBUTION DEPLOYMENTS

Time and phase testing is where most of the interest resides today, but it is also an area with important testing challenges. The TE threshold for a PRTC is 100 ns. For a Class B T-BC, the maximum TE is 70 ns, equivalent to the propagation delay of an electric signal over 15 - 20 m of coaxial cable. Measurement of these minute times requires a highly accurate time / phase reference and carefully designed measurement engines.

The fractional frequency offset and floor delay population are not relevant in phase / time deployments. Actually, a frequency offset of 1 ppb generates a phase error equivalent to around 90 μs in one day, much more than the accuracy figure required in this kind of deployment. Together with the MTIE and TDEV, the most important performance phase / time metric is the TE.

Network limits for phase and time applications are defined in ITU-T G.8271.1; limits for isolated entities (PRTCs, T-GMs, T-BCs, etc) are spread throughout different standards. This document deals mainly with network limits and the applications considered in ITU-T G.8271.1. Among the most important of these applications are 3G and 4G cellular communications systems requiring a phase accuracy of 1.5 μs or better.

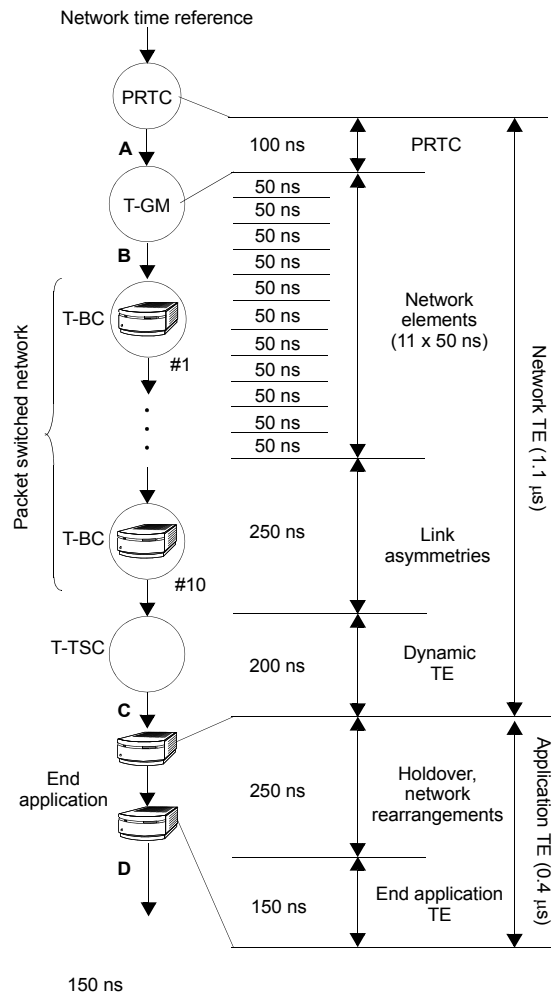

Figure 16 Time Error budget in a phase / time delivery application. TE control requires careful planning in these applications.

In order to guarantee that the phase offset between any two base stations or enhanced Nodes-B's (eNBs) is to remain within specified limits, the whole network has to be carefully engineered. Each network element (and also the transmission medium!) is constrained to specific operational limits in terms of TE. The network oper-

ALBEDO Telecom - Registered in Barcelona. Book 41613, Page 155, Sheet B-390886 - VAT : ESB6523022

Table 11

Performance limits in time distribution applications

Interface	Limit (ITU-T)
PTP network	G.8271.1
PTP equipment	G.8272, G.8273.x

ator is expected to consider also the TE already present in the PRTC / P-GM, variable TE due to random phase noise processes and TE generated in the application end. In case some critical equipment loses all external clock references it will enter in holdover status and it will start drifting. This condition should be planned from the beginning and some margin should be reserved to accommodate temporary holdover in the timing distribution equipment. All these considerations about performance make up the so called TE budget for the deployment.

An interesting fact about phase / time synchronization applications is that a network clock could declare a partial holdover condition when all time references become unavailable but there are still some usable frequency references. It is even possible that some network clocks could merge the timing information from a frequency reference and a time reference to get the best of each. The natural choice is then to use Synchronous Ethernet for frequency and PTP for time. A unit that has declared a partial holdover loses traceability to a universally accepted time scale such as TAI but it is still able to supply an accurate time for a long time. The consequence of combined Synchronous Ethernet / PTP deployments in testing practices is that it becomes important to run simultaneous Synchronous Ethernet and PTP tests.

The 1 PPS Interface

In phase / time application commissioning, the test interface could either be the packet interface or 1 PPS interface. Using 1 PPS for testing is popular because it allows for more simple testing tools but on the other hand these interfaces may not be always available. In some other situations it may be useful to compare performance results in 1 PPS and packet interfaces to rate certain network elements.

At first glance, 1 PPS looks like a quite simple interface. The 1 PPS source generates a pulse once per second. This pulse is transmitted at accurate times and it can then be used to signal transitions from second to second. In order to achieve a high degree of accuracy, the pulse rise times have to be controlled (< 5 ns in the 50Ω 1 PPS interface) and hence a wide-band transmission medium is re-

quired. Bandwidth requirements limit cable lengths in this kind of link (< 3 m in the 50Ω 1 PPS interface).

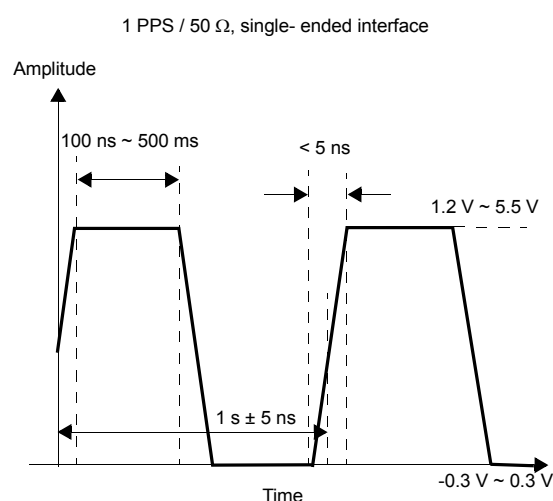

Figure 17 1PPS pulse shape specification in 50Ω , single ended interfaces. This interface is described in ITU-T G.703 and G.8271.

For some time, many 1 PPS implementations have coexisted but now two standard interfaces have been defined in ITU-T G.703 and G.8271. One of them is an unbalanced interface designed to operate over a 50Ω coaxial cable and the second is a balanced interface based on the ITU-T V.11 / RS-422 data communications standard and designed to operate over 100Ω wire with RJ-45 connectors. 1 PPS interfaces operating over RS-232 are still quite though.

The main difference between the unbalanced and the ITU-T V.11 / RS-422 interfaces is that the latter can accommodate a data communications channel to distribute *Time-of-Day* (ToD) messages. The ToD message adds a time scale to the 1 PPS signal, which considered alone carries information about phase but not absolute time.

Unlike for 1 PPS, there is not a unique or at least there is not a single clear candidate for ToD message formatting. The *National Marine Electronic Association* (NMEA) has developed specification that defines the messaging interface between marine electronic devices including compasses, RADAR equipment, computers and many others.

One common version of NMEA is version 0183 that uses a simple ASCII character formatting to distribute data from a single transmitter to one or several destinations. All NMEA-0183 talker messages have a similar structure. They all start with the “\$” character followed by a variable number of fields:

- Two characters to identify the talker equipment, the entity that generates the message. For example *HC* is used if the message is generated by a magnetic compass; *GP* is for a GPS receiver.
- Three characters identify the message type. For example *CGA* messages contain GPS fix data, *GLL* is used for latitude / longitude geographic position, *MTW* is for water temperature messages, *ZDA* contains time and date information with local time zone information, etc.
- It has a variable number of numeric or alphanumeric fields separated with commas. The maximum length of a NMEA-0184 message is 80 characters plus the start of message and the end of line sequences.
- A checksum code that uses the “*” character as a separator.
- The NMEA message finishes with an end of line character sequence.

An example of a NMEA-0184 talker message generated by a GPS receiver to communicate geographical position is:

\$GPGLL,4130.00,N,210.52,W,162012,A*1D

Table 12
NMEA-0184 GLL message structure

Field(s)	Meaning
GP	Talker identifier, GPS receiver
GLL	Geographic position, latitude and longitude
4130.00,N	Latitude 41 deg. 30.00 min. North
210.52,W	Longitude 2 deg. 10.52 min, East
162012	Fix taken at 16:20:12 UTC
A	Data valid (A) or invalid (V)
*10	Checksum

The ZDA message could be used to distribute information about time as in the following example:

\$ZAZDA,152713,01,07,2016,00,00*3F

Table 13
NMEA-0184 ZDA message structure

Field(s)	Meaning
ZA	Talker identifier, timekeeper, atomic clock
ZDA	Date and time information
152713	UTC time, 15:27:13
01	Day, 1st
07	Month, July
2016	Year, 2016
00	Local zone offset from UTC (0 hours)
00	Local zone offset from UTC (0 minutes)
*3F	Checksum

This message format is perfectly suitable to be used by timekeeping equipment to share time scale information in a 1 PPS / ToD interface.

Finally, the NMEA specification could also be used to generate queries to certain device types. Moreover, the structure is extensible with proprietary messages. NMEA-0184 queries and proprietary messages have their own specific syntax.

Path asymmetry and TE

The basic performance parameter for phase and time deployments is TE. Basically, TE tells how much the time is ahead or behind some reference time in a network clock. TE is generated in PTP-aware and non-PTP-aware network entities. Moreover, the transmission medium could also contribute to the TE. There are two mechanisms that could potentially generate TE:

- *Due to limited PRTC performance*, the time distributed through the network may not be accurate. If the PRTC is in holdover status an additional phase offset is expected to happen. This offset will be propagated to all the equipments locked to the PRTC.
- *Due to path delay asymmetry* the master-to-slave and the slave-to-master propagation delays may not be the same. It is not difficult to see that the TE generated by path asymmetry is one half of the value of the asymmetry. For example if the master-to-slave latency is 1 μs different compared with the

slave-to-master latency, then the induced TE in the PTP slave will be 500 ns.

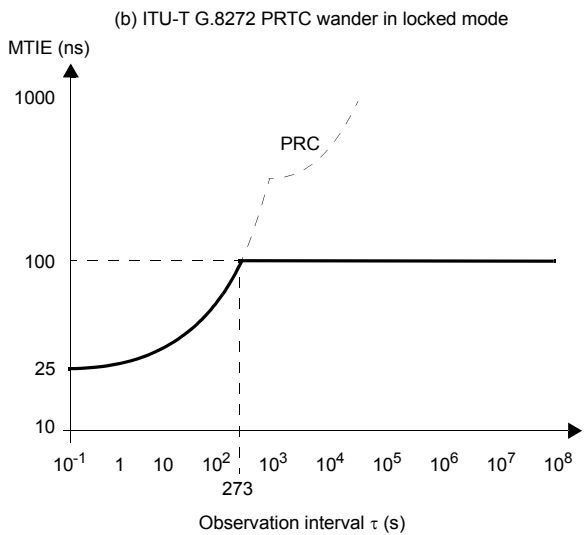
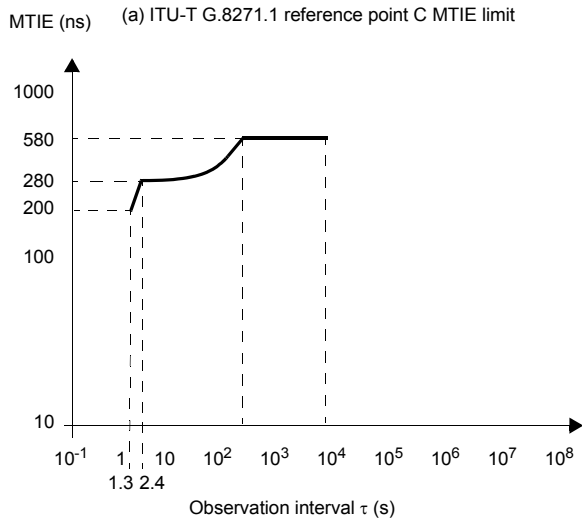

Figure 18 MTIE limits at the PRTC output and at the input of the T-TSC in a phase / time delivery application. Both are scaled to the same axis to see the difference between them.

Given a TE result, there is no way to know if it is caused by path asymmetry or PRTC limited accuracy. Not even looking at the master-to-slave and slave-to-master test results help determining the TE origin as these metrics are computed based on both the PRTC time and the local time reference.

The TE could accumulate through long transmission paths. The way the TE is accumulated and the potential degradation it could cause depends on how it is generated. The total TE could be classified as constant TE (cTE) and dynamic TE (dTE).

- *cTE* expresses TE components that are immune to filtering. Such TE components are the result of, for example, asymmetry in the transmission medium between network elements or asymmetries within network elements. It is often assumed that the *cTE* spans the frequency band between 0 and 0.1 Hz. Constant (0 Hz) *cTE* could theoretically be compensated through static setting in the slave equipment, but slowly varying TE with periods of hours or days is both difficult to compensate or filter and it therefore should be avoided as much as possible.
- The *dTE* is related to random noise accumulation due to T-BC time-stamping, packet-delay variation experienced by the timing signal packets or due to any other phase noise source. The power spectrum of the dynamic TE is spread out over the frequency spectrum and the power can be reduced, to some extent, through low-pass filtering.

The basic ITU-T G.8271.1 TE operational limit is $\pm 1.5 \mu s$ (reference point C) but if one has to focus on the requirements for the timing distribution network only (reference point C), then the requirement is $\pm 1.1 \mu s$. Of these, 200 ns (peak-to-peak amplitude) constitutes the *dTE* limit, with the *dTE* including all frequency components above 0.1 Hz. There is also a ± 100 ns requirement for the PRTC output, in line with ITU-T G.8272. If the PRTC is integrated with the T-GM, then the PRTC output is not available for testing and the ± 100 ns limit applies to the T-GM output instead. These measurements could be done either over the packet interface or in a clock output at the T-GM or T-TSC.

These limits provide an answer to the question: Is the network performance good enough to support phase and time delivery applications? However if the answer is not affirmative, they don't tell why. To answer this question more tests are necessary and these will need to be carried out at other locations different to the reference points listed in the standard. The expected results at different locations in the network could be inferred from the TE budget planned by the network administrator. Using the TE budget it can be verified which network elements are generating more TE than expected.

ALBEDO Telecom - Registered in Barcelona. Book 41613, Page 155, Sheet B-390886 - VAT : ESB6523022

MTIE and TDEV

MTIE and TDEV are still important performance metrics in phase / time distribution deployments but the way they are used is slightly different in phase deployments. The TDEV and specially the MTIE could be used to measure slowly varying TE. In the same way that a constant frequency offset requirement could be added to the MTIE mask through a straight line with specific slope, a phase requirement could be added through an horizontal line with the phase offset requirement being the distance of the line to the horizontal axis.

This approach is used by standards ITU-T G.8271.1 and G.8272, among others. The MTIE at the PRTC is up to 100 ns, the T-TSC MTIE contains components up to 580 ns. In a T-BC, the MTIE is 40 ns when the input is considered free of any impairment.

6. BIBLIOGRAPHY

- [1] IEEE Std. 1588-2008, "IEEE Standard for a Precision Clock Synchronization Protocol for Networked Measurement and Control Systems", 24 July 2008.
- [2] ITU-T G.703, "Physical/electrical characteristics of hierarchical digital interfaces", November 2001.
- [3] ITU-T G.781, "Synchronization layer functions", September 2008.
- [4] ITU-T G.810, "Definitions and terminology for synchronization networks", August 1996.
- [5] ITU-T G.811, "Timing characteristics of primary reference clocks", September 1997.
- [6] ITU-T G.812, "Timing requirements of slave clocks suitable for use as node clocks in synchronization networks", June 2004.
- [7] ITU-T G.813, "Timing characteristics of SDH equipment slave clocks (SEC)", March 2003.
- [8] ITU-T G.823, "The control of jitter and wander within digital networks which are based on the 2048 kbit/s hierarchy", March 2000.
- [9] ITU-T G.824, "The control of jitter and wander within digital networks which are based on the 1544 kbit/s hierarchy", March 2000.
- [10] ITU-T G.8260, "Definitions and terminology for synchronization in packet networks", February 2012.
- [11] ITU-T G.8261 / Y.1361, "Timing and synchronization aspects in packet networks", August 2013.
- [12] ITU-T G.8261.1 / Y.1361.1, "Packet delay variation network limits applicable to packet-based methods (Frequency synchronization)", February 2012.
- [13] ITU-T G.8262 / Y.1362, "Timing characteristics of synchronous Ethernet equipment slave clock", January 2015.
- [14] ITU-T G.8263 / Y.1363, "Timing characteristics of packet-based equipment clocks", February 2012.
- [15] ITU-T G.8264 / Y.1364, "Distribution of timing information through packet networks", May 2014.
- [16] ITU-T G.8265 / Y.1365, "Architecture and requirements for packet-based frequency delivery", November 2010.
- [17] ITU-T G.8261.1 / Y.1365.1, "Precision time protocol telecom profile for frequency synchronization", July 2014.
- [18] ITU-T G.8271 / Y.1366, "Time and phase synchronization aspects of packet networks", February 2012.
- [19] ITU-T G.8271.1 / Y.1366.1, "Network limits for time synchronization in packet networks", August 2013.
- [20] ITU-T G.8272 / Y.1367, "Timing characteristics of primary reference time clocks", January 2015.
- [21] ITU-T G.8273 / Y.1368, "Framework of phase and time clocks", August 2013.
- [22] ITU-T G.8273.2 / Y.1368.2, "Timing characteristics of telecom boundary clocks and telecom time slave clocks", April 2014.
- [23] ITU-T G.8275 / Y.1369, "Architecture and requirements for packet-based time and phase distribution", November 2013.
- [24] ITU-T G.8275.1 / Y.1369.1, "Precision time protocol telecom profile for phase/time synchronization with full timing support from the network", July 2014.
- [25] ITU-T O.174, "Jitter and wander measuring equipment for digital systems which are based on synchronous Ethernet technology", November 2009.